

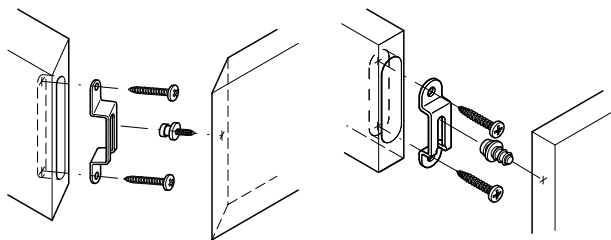

Modular Connection fitting

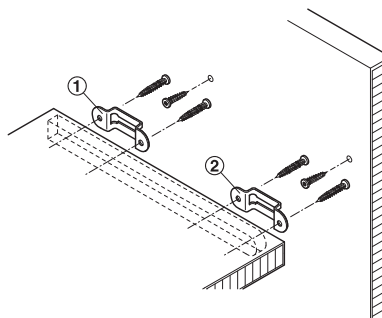

The Modular plate should always be installed so that the supporting plate butts against the top edge of the recess.



- ① For push fitting, for shelves
- ② For rapid release fastenings, as end stop

The Modular system fitting for rapid release connections (Cat. No. 262.47.021) is recommended for front mounting.

Installation as connector

Installation for shelves

- > Material: Steel
- > Finish: Burnished
- > Installation: For recess installation

Connector Technology

→ For rapid release connections

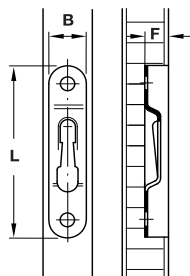

For wood thickness mm	Length L mm	Width B mm	Routing depth F mm	Cat. No.
Min. 16	63	12	8.3 ±0.05	262.47.049
Min. 17	58	13	11.3 ±0.05	262.47.021
Min. 20	58	16	11.5 ±0.05	262.47.076

Packing: 100 or 1000 pieces



→ Semi-locking, for semi-permanent connections

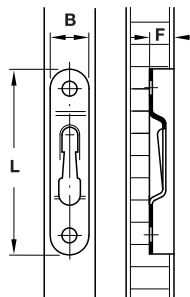

For wood thickness mm	Length L mm	Width B mm	Routing depth F mm	Cat. No.
Min. 13	63	11	8.3 ±0.05	262.47.094
Min. 16	63	12	8.3 ±0.05	262.47.058

Packing: 100 or 1000 pieces



→ For push fitting, for shelves

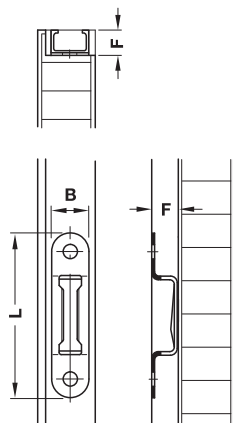

For wood thickness mm	Length L mm	Width B mm	Routing depth F mm	Cat. No.
Min. 17	58	13	11.3 ±0.05	262.47.003

Packing: 100 or 1000 pieces





→ Modular connecting bolts

With tip, for one-sided installation in wood

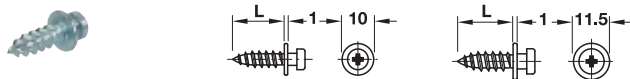

> Material: Steel
> Finish: Galvanized

For housing width mm	For drill hole Ø mm	Thread length L mm	Cat. No.
11-13	4	12.5	262.47.978
		16	262.47.987
		25	262.47.996
		32	262.47.870
16	5	16	262.47.889
		32	262.47.898

Packing: 100 or 500 pieces

Without tip, for one-sided installation in wood into series drilled holes



> Material: Steel
> Finish: Galvanized

For housing width mm	For drill hole Ø mm	Cat. No.
11-13	5	262.47.807

Packing: 100 or 1000 pieces

For double-sided installation in wood



> Material: Steel
> Finish: Galvanized

Supplied with

- 1 Threaded sleeve, M4 5 x 18 mm
- 2 Modular screws

For housing width mm	For wood thickness mm	Cat. No.
10-13	18-21	262.47.952
	22-25	262.47.953

Packing: 100 pieces

For mounting in metal



> Material: Steel
> Finish: Galvanized
> Version: With self-tapping thread

For housing width mm	For drill hole Ø mm	Thread Ø mm	Cat. No.
11-13	4.2	3/16"	262.47.969

Packing: 100 or 1000 pieces

→ Centring pin



Application

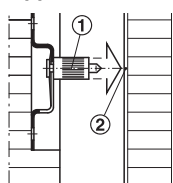

- ① Centring pin
- ② Centre-punch mark for screw hole

> Area of application: For marking drilling position for manual assembly
> Material: Steel
> Finish: Nickel plated

For housing width mm	Cat. No.
11-13	262.47.683

Packing: 1 piece