

Häfele Slido F-Line21 12C



- > Door weight: Min. 6 kg (recommended)
- > Door width: ≥ 325 mm with soft closing mechanism, ≥ 515 mm with soft closing and opening mechanism
- > Door thickness: 16–19 mm
- > Door stopper: Top clip-in door stopper or soft and self closing mechanism, for sliding into running track
- > Material: Housing, running gear and guide: Plastic
- > Running gear: Top running, 2 rollers
- > Running gear guided by: Friction bearing mounted roller: Plastic, axle: Steel
- > Adjustment facility: ± 1.5 mm on running gear using adjusting wheel
- > Installation: Housing for screw fixing, running gear without tools (quick fixing system), guide for press fitting into drill hole

Linear Sliding Doors

10

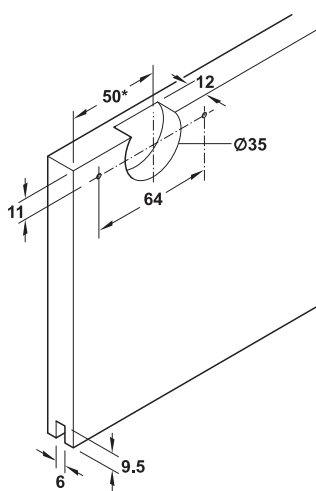

Drilling pattern

* = when using inspection support + 43 mm

Installation dimensions

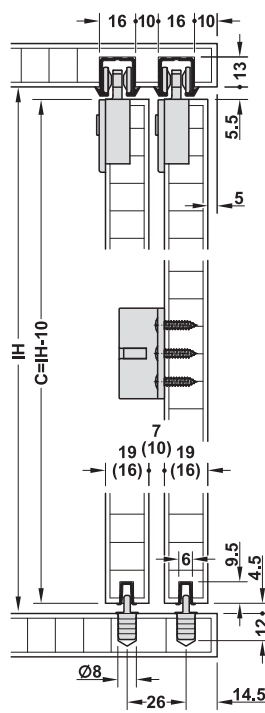

For groove mounting

IH = inner cabinet height
C = door height

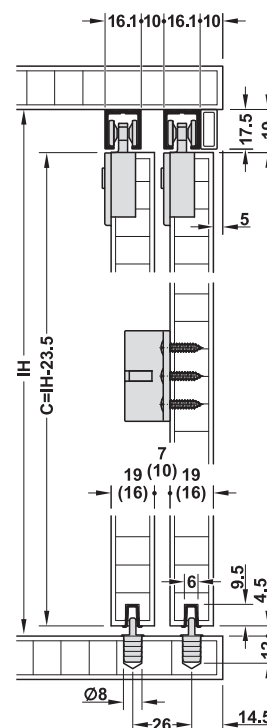

For screw fixing

Door overlap

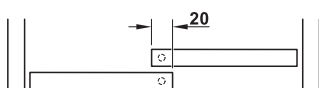

Cabinet with 2 doors

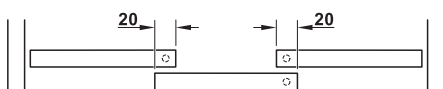

Cabinet with 3 doors

Running track versions



Single running track for press fitting



Double running track for press fitting



Single running track for screw fixing



Double running track for screw fixing

→ Set

	Version	Supplied with	Cat. No.
For 1 door	With clip-in door stopper	2 running gears 2 door stoppers with clip-in door stopper 1 inspection support 1 guide 1 mounting aid	402.33.011
	With soft and self closing mechanism on both sides, 12 kg	2 running gears with soft and self closing mechanism 2 door stoppers for soft and self closing mechanism 1 guide 1 mounting aid	402.33.012
For 2 doors	With clip-in door stopper	4 running gears 4 door stoppers with clip-in door stopper 1 door follower 2 inspection supports 2 guides 1 mounting aid	402.33.013
	With soft and self closing mechanism on one side, 12 kg	4 running gears (2 with soft and self closing mechanism left/right) 4 door stoppers (2 with clip-in door stopper/2 for soft and self closing mechanism) 1 door follower 2 guides 1 mounting aid	402.33.014
	With soft and self closing mechanism on both sides, 12 kg	4 running gears with soft and self closing mechanism 4 door stoppers for soft and self closing mechanism 1 door follower 2 guides 1 mounting aid	402.33.015

Packing: 1 set

Order reference







Please order running and guide tracks separately.

For cabinets with 3 doors, please order following sets: 1 set for 1 door and 1 set for 2 doors.

Note

The pitch length of the running gears must be min. 245 mm with soft closing mechanism on one side and min. 425 mm with soft closing mechanism on both sides. Inspection support cannot be used in combination with running gear with soft and self closing mechanism (inspection support cannot be ordered separately).

→ Tracks and accessories

		Cabinet top panel thickness mm	Material	Finish/colour	Length m	Cat. No.
Single top running track, for press fitting and glue fixing into groove 16 mm or for screw fixing with countersunk head screws 3 mm		Glue fixing: Min. 19; screw fixing: Min. 30	Aluminium	Bright, visible areas grooved	2.5	402.33.642
					3.5	402.33.643
Double top running track, for press fitting and glue fixing into groove 16 mm or for screw fixing with countersunk head screws 3.5 mm		Glue fixing: Min. 19; screw fixing: Min. 30	Aluminium	Bright, visible areas grooved	2.5	402.33.652
					3.5	402.33.653
Single top running track, for screw fixing with countersunk head screws 3.5 mm		-	Aluminium	Silver coloured anodized	2.5	402.30.642
					3.5	402.30.643
Double top running track, for screw fixing with countersunk head screws 3.5 mm, for door thickness 19 mm		-	Aluminium	Silver coloured anodized	2.5	402.30.652
					3.5	402.30.653
Single bottom guide track, with harpoon rib, for press fitting and glue fixing into groove 6 mm		-	Plastic	Grey	2.5	402.30.802
					3.5	402.30.803
Panel profile for glue fixing with adhesive strips		-	Aluminium	Silver coloured anodized	2.5	402.33.412
					3.5	402.33.413

Packing: 1 piece

Handles for sliding doors

► MB 10.233