

Häfele Slido D-Line11 240P Sliding door fitting



- > Area of application: For 1-leaf and 2-leaf sliding doors
- > Door weight: ≤240 kg
- > Adjustment facility: Door height adjustable
- > Installation: For wall mounting and ceiling installation, suspension with screwed-on support flange

Note

End cap for ceiling installation with fascia on both sides not available. One pair of end caps can be glue fixed vertically in the centre of the running track (optional).

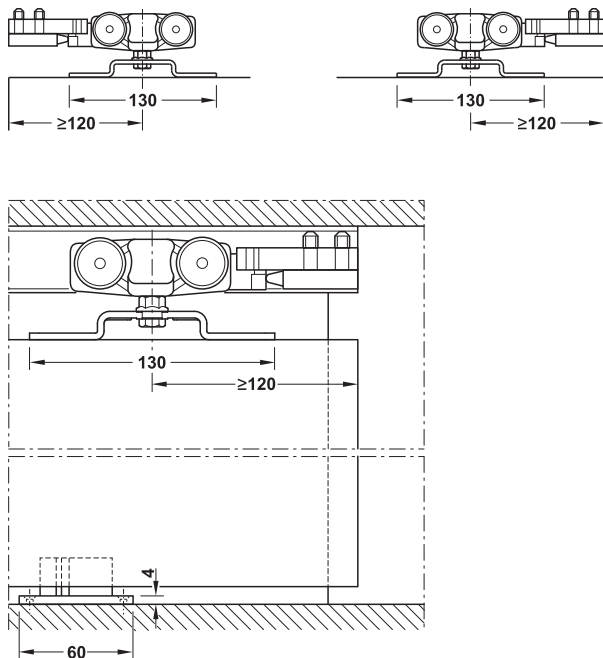

Section trolley hanger and guide

Wall mounting

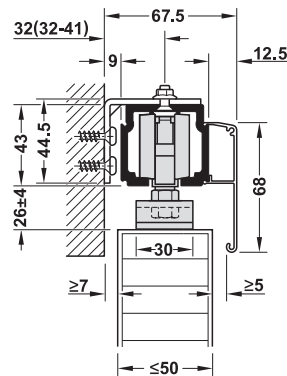

Ceiling installation

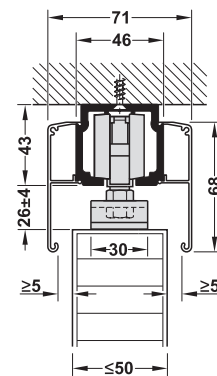

Guides

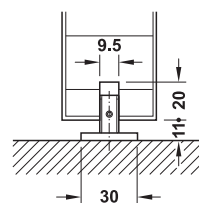

Clear threshold floor guide without guide track

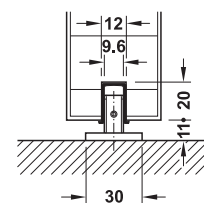

Clear threshold floor guide with guide track

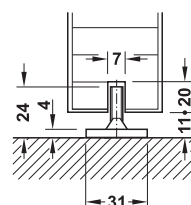

Floor guide without guide track

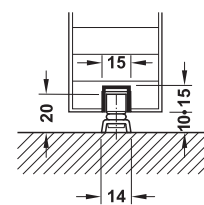

Floor guide with U-shaped guide track and floor guide roller

7



DGH-B-INT 2019, HDE-en, 12/18; Dimensional data not binding. We reserve the right to alter specifications without notice.







→ Set without running track for 1 door

Model	Version	Supplied with	Cat. No.
240P	Without soft and self closing mechanism	2 running gears 1 clear threshold floor guide 2 track buffers with retaining spring	942.35.004

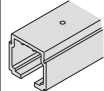
Order reference

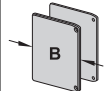
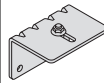
Order 2 sets for 2-leaf sliding doors.

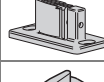
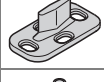
→ Tracks and accessories

		Material	Finish/colour	Width B mm	Length mm	Cat. No.
Wall mounting and ceiling installation						
Running track, pre-drilled, 46 x 43 mm (W x H)		Aluminium	Silver coloured anodized	–	3000	941.62.603
					6000	941.62.606
Clip panel, height 68 mm		Aluminium	Silver coloured anodized	–	3000	940.43.130
					6000	940.43.160
End cap set for panel, height 68 mm		Plastic	Silver coloured	68	–	941.62.020
Wall mounting						
Mounting bracket, height 44.5 mm (install every 400 mm)		Steel	Zinc plated	–	51	941.62.416
Accessories						
Guide track, bottom, for press fitting		Plastic	Black	–	1000	940.42.050
					1500	940.42.051
					2000	940.42.052
Clear threshold floor guide		Plastic	Black	–	–	940.42.030
Floor guide, plastic		Plastic	Black	–	–	942.35.400
Floor guide roller, Ø 10 mm		Steel	Zinc plated	–	–	940.42.032
U-shaped guide track, 15 x 15 x 1.5 mm		Aluminium	Bright	–	6000	940.42.602

DGH-B-INT 2019, HDE-en, 12/18; Dimensional data not binding. We reserve the right to alter specifications without notice.

Door handles for sliding doors ▶ AH 1.74

▶ AH 7.194

Mortice locks ▶ AH 2.32

Door seals for sliding doors ▶ AH 7.104