

Bessey TG/TGK Screw-clamp



Tensioning arms: Malleable cast, wooden handle, with ergonomic handle

Model TG: with protective cap on the clamping surfaces, clamping force up to 6,000 N

Model TGK: without protective cap on the clamping surfaces, clamping force up to 7,000 N

Packing: 1 piece

Opening mm	Throat depth mm	Model	Cat. No.
100	50	TG10	003.69.801
160	80	TG16	003.69.803
200	100	TG20	003.69.804
250	120	TG25	003.69.805
300	140	TG30	003.69.806
400	175	TG40	003.69.807
500	120	TGK50	003.69.808
600	120	TGK60	003.69.809
800	120	TGK80	003.69.810
1,000	120	TGK100	003.69.811
1250	120	TGK125	003.69.812
1500	120	TGK150	003.69.813
2000	120	TGK200	003.69.815

Bessey GZ All-steel screw-clamp



With ergonomic handle, clamping force up to 6,000 N

Material: tensioning arms all-steel, tempered, wooden handle

Packing: 1 piece

Opening mm	Throat depth mm	Cat. No.
120	60	003.71.013
160	80	003.71.022
200	100	003.71.031
250	120	003.71.040
300	140	003.71.059
400	120	003.71.068
600	120	003.71.077

Bessey KT Edge clamp



For tightening strips and edge bands, for clamping onto profile rails of screw-clamps, suitable for use with commercial screw-clamps with max. rail thickness of 13 mm

Material:

Body: steel

Handle: wood

Packing: 1 piece

Cat. No.
Edge clamp
003.71.719

Bessey Kli Klamp Lever clamp



Gentle tightening due to swivelling pressure plate, lightweight and stable, clamping force up to 1,200 N
 Material: fixed and sliding jaw made of magnesium, ratchet made of glass fibre reinforced plastic
 Throat depth: 80 mm

Packing: 1 or 6 pieces

Opening mm	Weight kg	Cat. No.
160	Approx. 0.29	003.71.102
200	Approx. 0.32	003.71.103
250	Approx. 0.355	003.71.104

Bessey EZ One-handed clamp



For clamping and spreading, handy two component handle for quick and precise clamping pressure, quick tightening provided by pistol grip and instant release on pressure, clamping jaws with protective caps, clamping force approx. 700 N
 Clamping rail: steel, hardened
 Protective caps: plastic

Packing: 1 piece

Opening mm	Throat depth mm	Spreading width mm	Cat. No.
150	60	130–315	003.72.804

Bessey EZS One-handed clamp



Universal quick action clamp for clamping and spreading, handy two component handle for quick and precise clamping pressure, for clamping the clamping jaw in any position on the rail, clamping jaws with protective caps, fast switching between clamping and spreading clamp, quick release by briefly pressing release lever, clamping force approx. 2,000 N

Clamping rail: steel, hardened
 Protective caps: plastic

Packing: 1 piece

Opening mm	Throat depth mm	Spreading width mm	Cat. No.
150	80	170–360	003.72.800
300	80	170–510	003.72.801
450	80	170–660	003.72.802
600	80	170–810	003.72.803

Bessey Uni Klamp Universal clamp

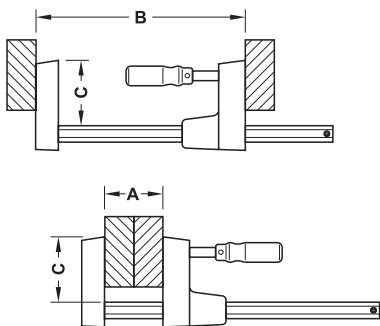

For clamping and spreading of sensitive surfaces, round and sharp workpieces with large clamping surfaces, also tightens on the side and behind the rail, clamping force up to 1,500 N

Technical data:

Opening A mm	Spreading width B mm	Throat depth C mm	Rail mm	Weight kg approx.
160	172-270	80	20 x 5	0.6
600	172-720	80	20 x 5	0.93

Opening mm	Packing pieces	Cat. No.
160	1	003.72.721
600	1 or 6	003.72.723

Cam clamp

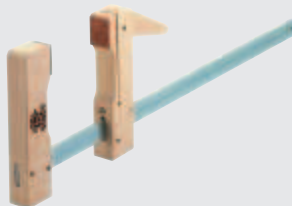

Material: tensioning arms made of hornbeam, steel rails, clamping surface cork coated
Throat depth: 110 mm

Packing: 1 piece

Opening mm	Cat. No.
200	003.73.026
400	003.73.044
600	003.73.062

→ Combination replacement part for cam clamp

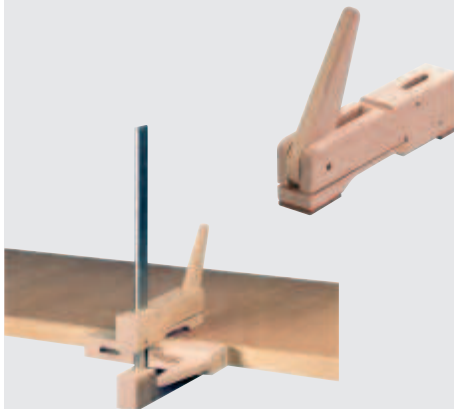

For additional tightening of edges and edge bands or as replacement tensioning arm
Material: hornbeam

Packing: 1 piece

Combination replacement part	Cat. No.
	003.73.106

Bessey Revo KR Body clamp

Very large parallel clamping surfaces with 3 removable protective caps to protect delicate surfaces, can be converted to spreading function without tools, high quality 2-component plastic handle with hexagon socket for comfortably reaching the clamping force (max. torque 17 Nm)

Metal reinforced plastic housing and optimised sliding arm with double slide protection for more power and reliability. The clamping force is maintained and any unintentional slipping of the sliding arm is prevented when in the unclamped position.

Clamping force: ≤ 8000 N,
Throat depth: 95 mm

Packing: 1 or 2 pieces

Opening mm	Spreading width mm	Cat. No.
600	730	003.72.205
800	930	003.72.206
1,000	1130	003.72.207
1250	1355	003.72.208

Bessey PS 130 Seaming tool

For tightening and positioning large-scale, also heavy components with a smooth surface, such as artificial stone, ceramic, granite, Corian®, plastic, sheet metal and glass

Vacuum pumps with control function, clamping force up to 1,200 N, with release button for quick removal, robust design

Vacuum cup \varnothing : 210 mm
Length: 770 mm



Packing: 1 piece

Cat. No.
PS130 seaming tool
006.69.000

Bessey One-handed edge clamp

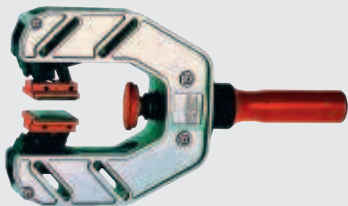

With micro-coated surface (does not rub off),
 with removable plastic caps,
 with ergonomic handle,
 with double spindle (outer spindle moves jaws,
 inner spindle generates pressure on the edge)

Material:

Housing: aluminium

Pressure plates: yellow chromatised

Handle: impact-resistant plastic

Weight: 0.82 kg

Application examples

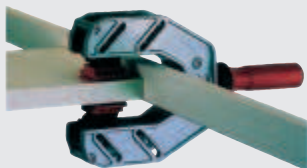
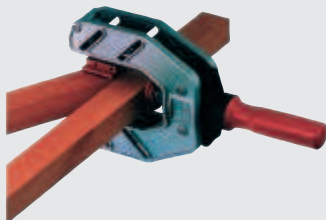

Packing: 1 or 6 pieces

Opening mm	Throat depth mm	Cat. No.
10–55	0–45	003.73.830

Bessey Clippix Spring clamp



Versatile, can be used as a cam clamp, for example
 with non-slip grip pads,
 with softpads for sensitive workpieces

Packing: 1 or 10 pieces

Opening mm	Throat depth mm	Cat. No.
50	50	003.75.120
75	70	003.75.130

Bessey AV2 Spacer



For floating installation of laminate and prefinished
 parquet floors without wedges,
 continuously adjustable for wall distance 5–20 mm,
 with practical turn knob,
 wide clamping and support surface, with millimetre scale,
 robust, light and compact
 Material: plastic

Packing: 4 pieces

	Cat. No.
Spacer	003.71.661

Mitre spring clamp set

For tightening strips and edge bands,
for clamping on profile rails of screw-clamps

Supplied with:

1 spreader pliers

8 steel clamps each for strip widths:

10–15 mm, 15–25 mm, 20–30 mm, 25–45 mm,

40–70 mm, 65–90 mm

Packing: 1 set

	Cat. No.
Mitre spring clamp set	003.74.256

Mitre spring clamp

Material: round steel

Packing: 10 pieces

Area of application	Cat. No.
For strip widths up to 15 mm	003.74.318
For strip widths up to 25 mm	003.74.327

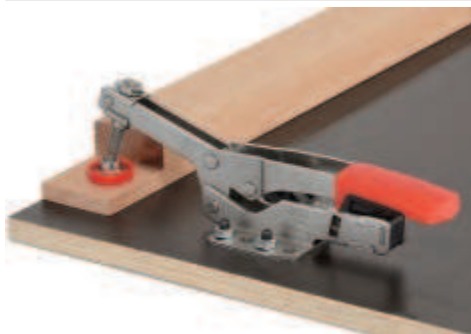
Bessey STC-HH50 Quick-action clamp, variable

Characteristics: Horizontal toggle clamp with open arm,
area of application: Clamp more flexibly and up to
5x faster, sensitive workpieces with a veneered or
lacquered surface, for example, can be clamped without
damage, adapts to workpieces with different thicknesses
with approximately equal clamping force, without
manually adjusting the pressure screw
Version: extremely wide tightening range thanks
to patented mechanism, clamping force regulation
via adjusting screw in joint
Automatic adjustment: 35 mm
Clamping force: 2,500 N
Opening: 40 mm

Packing: 1 piece

Model	Cat. No.
STC-HH50	003.71.240

Bessey TU Door frame clamp

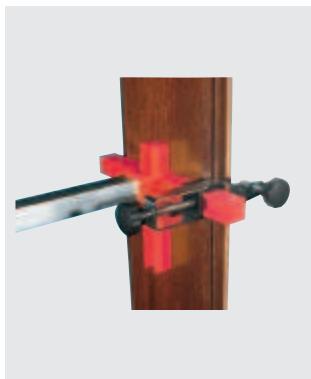

Interchangeable clamping elements with increased clamping surfaces and removable straightening clamps to fix the door frame securely and easily, strut with millimetre scale and clamping screw, clamping surfaces with felt protection
 Material:
 Rail: aluminium anodized
 Jaws: plastic

Packing: 2 pieces

Opening mm	Cat. No.
565 – 1010	003.74.680

Bessey TFM Door frame straightening clamp



For fast and accurate alignment and fixing of the door frames with ergonomic handles, burr-free riveted with spindle, with large protective caps for gentle support to the wall

Packing: 2 pieces

	Cat. No.
Door frame straightening clamp	003.74.658

Bessey WTR Angled door frame straightening clamp



For aligning door frames
 With ergonomic handles, burr-free riveted with spindle, with large protective caps for gentle support to the wall, rotary handle with trapezoidal threaded spindle for aligning, movable lever with return spring
 Adjusting distance: 32 mm
 Opening: 8–30 mm
 Material:
 Body: glass fibre reinforced polyamide
 Counterpart: steel, galvanized, wooden handle

Packing: 2 pieces

	Cat. No.
WTR door frame straightening clamp	003.74.650

Inflatable mounting bag

For avoiding scratches,
for easy and precise fitting, no wedge consumption,
completely empty gaps, time savings
Load bearing capacity: 100 kg/piece
Width: gap 2–50 mm
Material: fibre reinforced plastic

**Supplied with:**

4 inflatable mounting bag with belt hook

Packing: 1 set

	Cat. No.
Inflatable mounting bag	003.74.790

Universal pinch bar

With robust wooden handle,
striking ring

Packing: 1 piece

Length	Cat. No.
Blade approx. 135 mm	000.30.900