

Breakfast bar supports for mounting on worktops or furniture

→ Straight, flat



- > Load bearing capacity: 30 kg
- > Installation: For screw fixing

**Note**

There is a height difference of +10 mm when using the glass adapter.

**Supplied with**

Fixing material

Material	Finish/colour	Cat. No.
Aluminium	Stainless steel coloured	505.22.051
	Jet black, RAL 9005, microstructure, matt	505.22.351

Packing: 1 piece

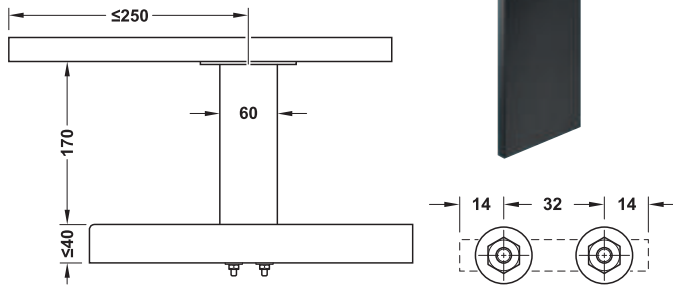

7

Midway Systems

→ Inclined, flat

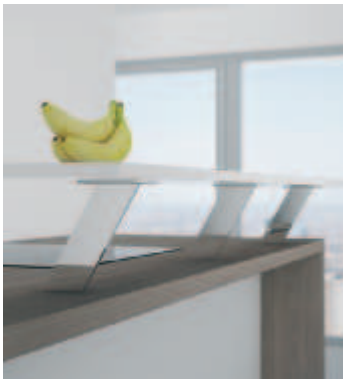

- > Load bearing capacity: 30 kg
- > Installation: For screw fixing

**Note**

There is a height difference of +10 mm when using the glass adapter.

**Supplied with**

Fixing material

Material	Finish/colour	Cat. No.
Steel	Chrome plated	505.22.241
Aluminium	Stainless steel coloured	505.22.041
Aluminium	Jet black, RAL 9005, microstructure, matt	505.22.341

Packing: 1 piece

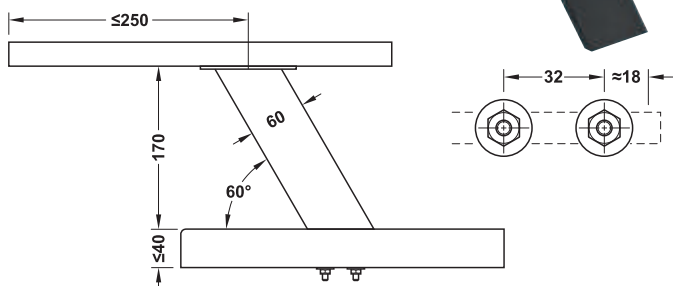

Glass adapter for glue fixing

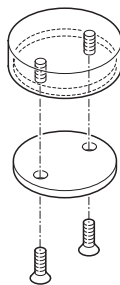

- > Area of application: For mounting glass panel on flat breakfast bar supports
- > Material: Stainless steel
- > Installation: Top for glue fixing and bottom for screw fixing
- > Diameter: 50 mm

Product type	Cat. No.
Glass adapter	505.22.081

Packing: 1

Table and bench leg frame	► MB 12.39
Glass gluing technique	► MB 14.16

→ Straight, square

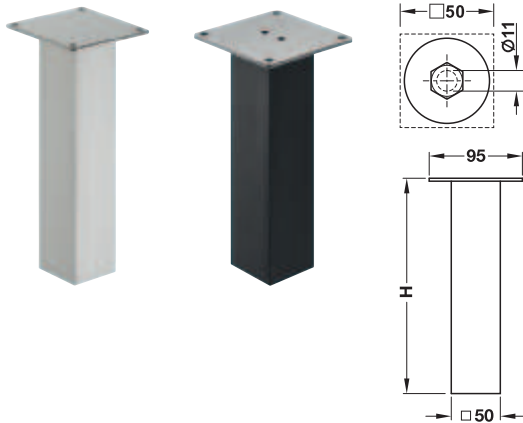

- > Material: Aluminium/steel
- > Load bearing capacity: 25 kg
- > Installation: For screw fixing

**Supplied with**  
Fixing material

Finish	Height H mm	Cat. No.
Stainless steel effect	170	505.21.011
	220	505.21.013
Jet black, RAL 9005, microstructure, matt, mounting plate: Silver	170	505.21.311
	220	505.21.313

Packing: 1 piece

→ Inclined, square

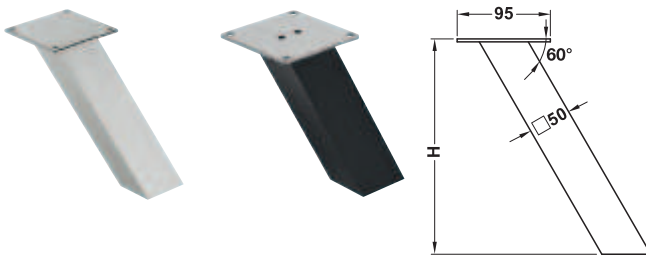

- > Material: Aluminium/steel
- > Load bearing capacity: 20 kg
- > Installation: For screw fixing

**Supplied with**  
Fixing material

Finish	Height H mm	Cat. No.
Stainless steel effect	170	505.21.031
	220	505.21.033
Jet black, RAL 9005, microstructure, matt, mounting plate: Silver	170	505.21.331
	220	505.21.333

Packing: 1 piece

Glass adapter for glue fixing

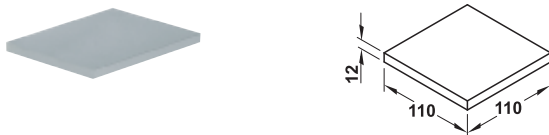

- > Area of application: For straight and inclined, square breakfast bar supports
- > Installation: For screw fixing to mounting plate

Material	Finish	Cat. No.
Aluminium	Silver coloured anodized	505.21.990

Packing: 1 piece

DGH-M 2021, HDE-en, 1/1/20; Dimensional data not binding. We reserve the right to alter specifications without notice.



Midway Systems

Table leg	► MB 12.52
Glass gluing technique	► MB 14.16

→ Inclined, Z-shape

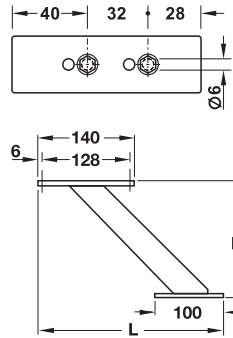

- > Material: Aluminium
- > Finish: Silver coloured matt, anodized E6/EV1
- > Load bearing capacity: 25 kg
- > Installation: For screw fixing

**Supplied with**  
Fixing material and drilling jig

Length L mm	Height H mm	Cat. No.
270	170	505.14.926
310	210	505.14.936

Packing: 1 piece



→ Inclined, Aluminium

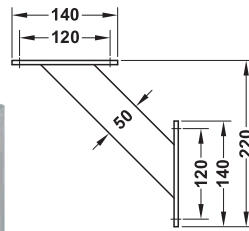
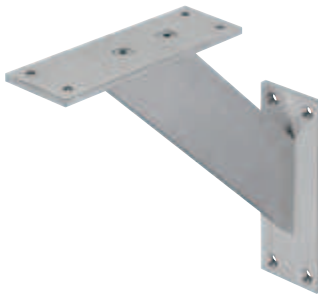

- > Material: Aluminium
- > Load bearing capacity: 50 kg
- > Installation: For screw fixing

**Supplied with**  
Fixing material

Height H mm	Finish	Cat. No.
195	Aluminium brushed	505.35.933
	Stainless steel effect	505.35.033
	Jet black, RAL 9005	505.35.333

Packing: 1 piece

7

Midway Systems

Breakfast bar supports for mounting laterally on cabinet or wall

→ Round

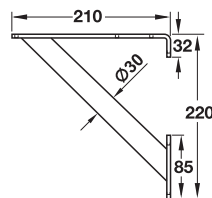

- > Material: Steel
- > Tube Ø: 30 mm
- > Load bearing capacity: 30 kg
- > Installation: For screw fixing

Finish	Cat. No.
Stainless steel coloured	505.20.010

Packing: 1 piece



→ Flat

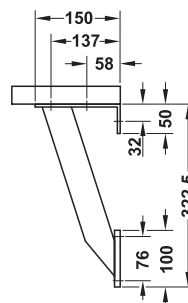

- > Material: Aluminium
- > Load bearing capacity: 30 kg
- > Installation: For screw fixing

**Supplied with**  
Fixing material

Finish	Cat. No.
Silver coloured matt, anodized E6/EV1	505.14.956

Packing: 1 piece