

Häfele Slido D-Line11 50-I to 120-I Sliding door fitting



Soft and self closing mechanism:

- > Low opening force – easy and convenient operation
- > Tested with increased speed up to 0.5 m/s
- > Can be retrofitted or replaced at any time

Shock absorber:

- > Closing speed with shock absorber tested up to 0.4 m/s



- > Suitable for: For wooden doors
- > Area of application: For 1-leaf and 2-leaf sliding doors
- > Door weight: ≤50/80/120 kg
- > Adjustment facility: Door height adjustable ±3 mm
- > Installation: Wall mounting and ceiling installation, suspension with integrated support flange

Sliding Door Fittings for Wooden Doors

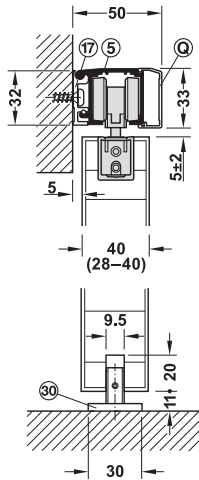

Section guide and trolley hanger

Wall mounting with mounting rail and clear threshold floor guide without guide track

Soft closing versions overview

Running gear with axle bearing

Without soft and self closing mechanism

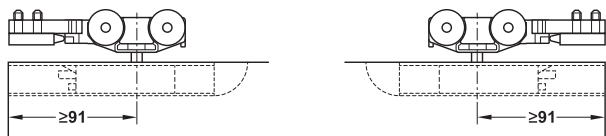

With soft and self closing mechanism on one side

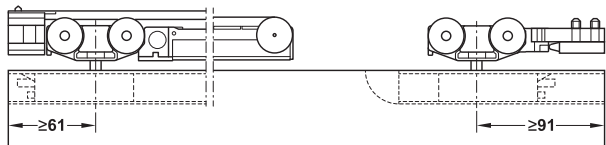

Running gear with ball bearing mounted rollers

With soft and self closing mechanism on one side and shock absorber

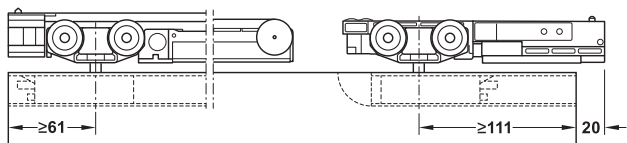

With soft and self closing mechanism on both sides

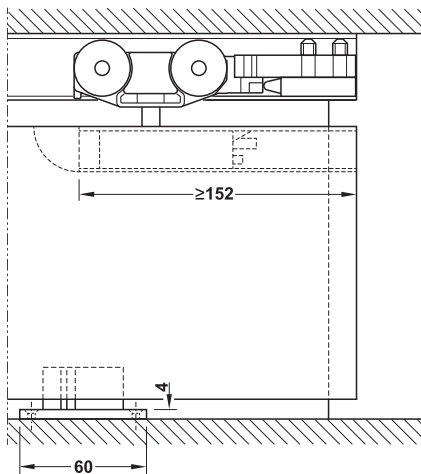
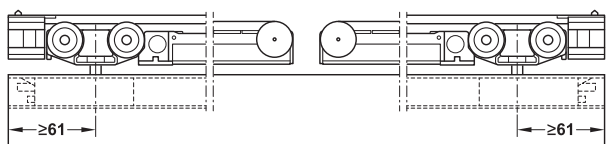

Routing dimensions

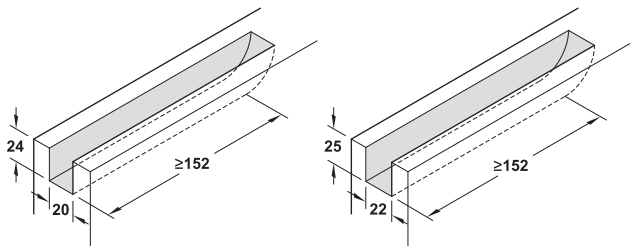

50I

80I and 120I

DGH-B-INT 2019, HDE-en, 12/18; Dimensional data not binding. We reserve the right to alter specifications without notice.

→ Set with running track for 1 door

Wall mounting with mounting rail

| Version | | Supplied with | Door width mm | 80l ≤80 kg per door |
|---|--------------------------------------|---|---------------|------------------------|
| Running gear with axle bearing | | | | |
| Without soft and self closing mechanism | Track buffer with retaining spring | 1 80l set 1 mounting rail (17) 2000 mm 1 running track (5) 2000 mm with threaded end inserts 1 panel (Q) 2000 mm with end caps | ≥500 | 940.83.068 |
| With soft and self closing mechanism on one side | Track buffer with retaining spring | 1 80l set 1 mounting rail (17) 2000 mm 1 running track (5) 2000 mm with threaded end inserts 1 panel (Q) 2000 mm with end caps | ≥499 | 940.83.069 |
| Running gear with ball bearing mounted rollers | | | | |
| With soft and self closing mechanism on one side | Shock absorber with retaining spring | 1 80l set 1 mounting rail (17) 2000 mm 1 running track (5) 2000 mm with threaded end inserts 1 panel (Q) 2000 mm with end caps | ≥538 | 940.83.070 |
| With soft and self closing mechanism on both sides | – | 1 80l set 1 mounting rail (17) 2000 mm 1 running track (5) 2000 mm with threaded end inserts 1 panel (Q) 2000 mm with end caps | ≥744 | 940.83.071 |

→ Set without running track for 1 door

| Version | | Supplied with | Door width mm | 50l ≤50 kg per door | 80l ≤80 kg per door | 120l ≤120 kg per door |
|---|--------------------------------------|---|--------------------------------------|------------------------|------------------------|--------------------------|
| Running gear with axle bearing | | | | | | |
| Without soft and self closing mechanism | Track buffer with retaining spring | 2 running gears with support flange 2 support profiles with cover cap 1 clear threshold floor guide 2 track buffers with retaining spring | ≥500 | 940.44.004 | 940.83.053 | 941.25.044 |
| With soft and self closing mechanism on one side | Track buffer with retaining spring | 2 running gears with support flange (1 with soft and self closing mechanism) 2 support profiles with cover cap 1 clear threshold floor guide 1 track buffer with retaining spring 1 release device with stopper for soft and self closing mechanism | ≥499 (50 and 80 kg) ≥561 (120 kg) | 940.44.005 | 940.83.054 | 941.25.045 |
| Running gear with ball bearing mounted rollers | | | | | | |
| With soft and self closing mechanism on one side | Shock absorber with retaining spring | 2 running gears with support flange (1 with soft and self closing mechanism) 2 support profiles with cover cap 1 clear threshold floor guide 1 shock absorber with retaining spring 1 release device with stopper for soft and self closing mechanism | ≥538 (50 and 80 kg) ≥600 (120 kg) | 940.44.006 | 940.83.055 | 941.25.046 |
| With soft and self closing mechanism on both sides | – | 2 running gears with support flange and soft and self closing mechanism 2 support profiles with cover cap 1 clear threshold floor guide 2 release devices with stopper for soft and self closing mechanism | ≥744 (50 and 80 kg) ≥868 (120 kg) | 940.44.007 | 940.83.056 | 941.25.047 |

Order reference

Please order track, panels and accessories separately. Order 2 sets for 2-leaf sliding doors.
Please order adjustment aid for adjusting the running gears (height and position) separately.

Note

Please note when using the shock absorber with retaining spring: The door may not close completely if the closing speed is too low, it is too high, the door may bounce back slightly. Sets without or with soft and self closing mechanism on one side can be retrofitted with soft and self closing mechanism or shock absorber, if required.

→ Accessories for retrofitting

| | | Load bearing capacity kg | Cat. No. |
|---|--|--------------------------|------------|
| Soft and self closing mechanism, with release device with stopper, for clamping onto running gear | | 50 | 940.42.304 |
| | | 80 | 940.83.300 |
| | | 120 | 941.02.300 |
| Shock absorber with retaining spring, for clamping onto running gear | | 50 | 940.42.305 |
| | | 80 | 940.83.301 |
| | | 120 | 941.02.301 |

Fixing options for Häfele Slido D-Line11 50l to 120l sliding door fitting

Wall mounting with mounting rail

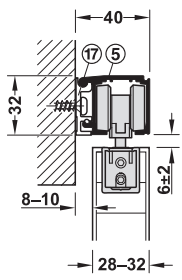

With running track ⑤, mounting rail ⑰ width 8 mm

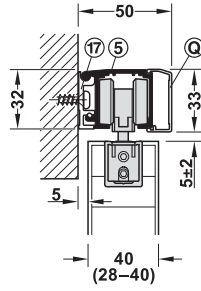

With running track ⑤, mounting rail ⑰ width 8 mm and clip panel ①

Ceiling installation

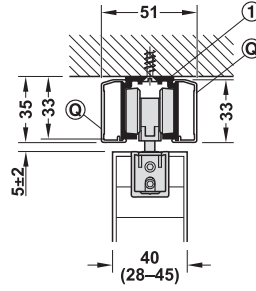

With running track ① and 2 x clip panel ①

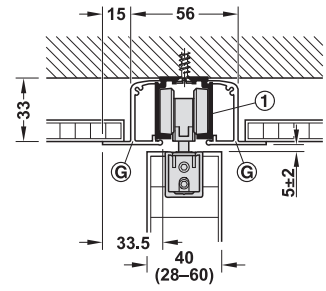

With running track ① and 2 x clip panel ①

Sliding Door Fittings for Wooden Doors

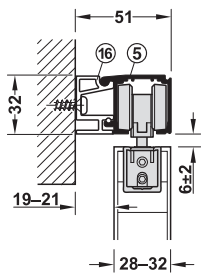

With running track ⑤, mounting rail ⑰ width 19 mm

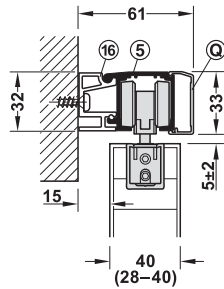

With running track ⑤, mounting rail ⑰ width 19 mm and clip panel ①

Guides

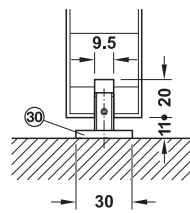

Clear threshold floor guide ③①, without guide track

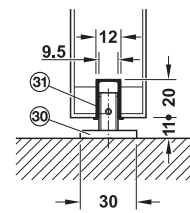

Clear threshold floor guide ③①, with guide track ③②

→ Tracks

| | | | Area of application | Material | Finish/colour | Length mm | Cat. No. |
|--|---|--|---------------------------|-----------|--------------------------|-----------|------------|
| Wall mounting and ceiling installation | | | | | | | |
| Single running track, pre-drilled, 31 x 33 mm (W x H) | ① | | For door weight 50–120 kg | Aluminium | Bright | 2000 | 940.43.921 |
| | | | | | | 3000 | 940.43.931 |
| | | | | | | 6000 | 940.43.961 |
| | | | | | Silver coloured anodized | 2000 | 940.43.922 |
| | | | | | | 3000 | 940.43.932 |
| | | | | | | 6000 | 940.43.962 |
| Wall mounting | | | | | | | |
| Single running track, mounting with mounting rail ⑩, ⑪, ⑫ 32 mm (H) | ⑤ | | For door weight 50–120 kg | Aluminium | Silver coloured anodized | 2000 | 941.25.602 |
| | | | | | | 3000 | 941.25.603 |
| | | | | | | 6000 | 941.25.606 |
| Mounting rail, pre-drilled, width 19 mm | ⑬ | | For door weight 50–120 kg | Aluminium | Silver coloured anodized | 2000 | 941.25.821 |
| | | | | | | 3000 | 941.25.831 |
| | | | | | | 6000 | 941.25.861 |
| Mounting rail, pre-drilled, width 8 mm | ⑭ | | For door weight 50–120 kg | Aluminium | Silver coloured anodized | 2000 | 941.25.820 |
| | | | | | | 3000 | 941.25.830 |
| | | | | | | 6000 | 941.25.860 |
| Ceiling installation | | | | | | | |
| Double running track, pre-drilled, 70 x 33 mm (W x H) | ③ | | For door weight 50–120 kg | Aluminium | Silver coloured anodized | 2000 | 941.02.920 |
| | | | | | | 3000 | 941.02.930 |
| | | | | | | 6000 | 941.02.960 |
| Double running track, pre-drilled, 81 x 33 mm (W x H) | ④ | | For door weight 50–120 kg | Aluminium | Silver coloured anodized | 2000 | 941.02.820 |
| | | | | | | 3000 | 941.02.830 |
| | | | | | | 6000 | 941.02.860 |

Note

Bright aluminium running track cannot be used in combination with a clip panel.

Order reference

Please order threaded end insert for running track ⑤ and mounting rail ⑬ or ⑭ separately.

Installation (running track ⑤ and mounting rail ⑬ or ⑭)

Slide in threaded end insert at rail ends. The running track and mounting rail ends must be fixed with glue points when installed between walls.

→ Mounting bracket and accessories

| | | | Area of application | Material | Finish/colour | Length L mm | Wall distance track centre mm | Cat. No. |
|--|---|--|---|----------|---------------|-------------|-------------------------------|------------|
| Mounting bracket with screw and nut (install every 400 mm) | ⑩ | | For running track ① | Steel | Zinc plated | 36 | 16–25 | 940.42.061 |
| | | | | | | 44 | 18–33 | 940.62.061 |
| | | | | | | 64 | 33–55 | 940.42.063 |
| Threaded end insert or safety lock screw for running track (1 set) | – | | For running track ⑤ and mounting rail ⑬, ⑭, ⑮ or ⑯ | Steel | Zinc plated | – | – | 941.25.090 |
| Adjustment aid with hex key | – | | For adjusting the running gears (height and position) | Plastic | | 90 | – | 940.42.075 |

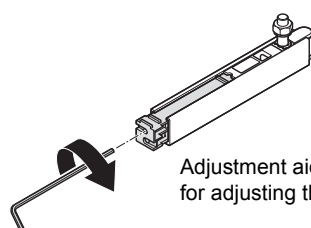

Adjustment aid with hex key for adjusting the running gears (height and position)

→ Panels

| | | | Area of application | Material | Finish/ colour | Length mm | Width B mm | Cat. No. |
|---|---|--|---|-----------|--------------------------------|--------------|---------------|------------|
| Clip panel, for integration in suspended ceilings | ⓐ | | For running track ①, ③ and ④ | Aluminium | Silver coloured anodized | 2000 | – | 940.43.620 |
| | | | | | | 3000 | – | 940.43.630 |
| | | | | | | 6000 | – | 940.43.660 |
| Clip panel, height 33 mm | ⓑ | | For running track ①, ③, ④ and ⑤ | Aluminium | Silver coloured anodized | 2000 | – | 941.25.620 |
| | | | | | | 3000 | – | 941.25.630 |
| | | | | | | 6000 | – | 941.25.660 |
| End cap set for panel ⓐ | – | | For running track ① for running track ⑤, with mounting rail ⑰ | Plastic | Silver coloured | – | 50 | 941.25.040 |
| | | | For running track ⑤, mounting rail ⑰ | Plastic | Silver coloured | – | 61 | 941.25.041 |
| End cap set for 2x panel ⓐ | – | | For running track ① | Plastic | Silver coloured | – | 51 | 941.25.042 |
| End cap set | – | | For running track ⑤, with mounting rail ⑰ | Plastic | Silver coloured anodized | – | 40 | 940.43.076 |
| | | | For running track ⑤, with mounting rail ⑰ | Plastic | Silver coloured anodized | – | 51 | 940.43.480 |

→ Guides

| | | | Area of application | Material | Finish/ colour | Length mm | Cat. No. |
|--|---|--|--|--------------------|-------------------|----------------------------|------------|
| Clear threshold floor guide | ⑳ | | For wooden doors with or without guide track ㉑ | Plastic | Black | – | 940.42.030 |
| Guide track, bottom, for press fitting | ㉑ | | For clear threshold floor guide ㉑ | Plastic | Black | 1000 | 940.42.050 |
| | | | | | | 1500 | 940.42.051 |
| | | | | | | 2000 | 940.42.052 |
| Clear threshold floor guide, for wall pocket installation | – | | For installation on one or both sides to front side of sliding door wall pocket, for gap width 8–8.5 mm | Stainless steel | – | 245, can be cut to size | 940.42.035 |

| | |
|---|------------|
| Door handles for sliding doors | ▶ AH 1.74 |
| | ▶ AH 7.194 |
| Mortice locks | ▶ AH 2.32 |
| Retractable door seal for sliding doors | ▶ AH 6.14 |
| Wall pocket solution | ▶ AH 7.29 |
| Track stopper | ▶ AH 7.38 |
| Stacking | ▶ AH 7.39 |
| Door seals for sliding doors | ▶ AH 7.104 |
| Flush pull handles | ▶ AH 7.188 |